

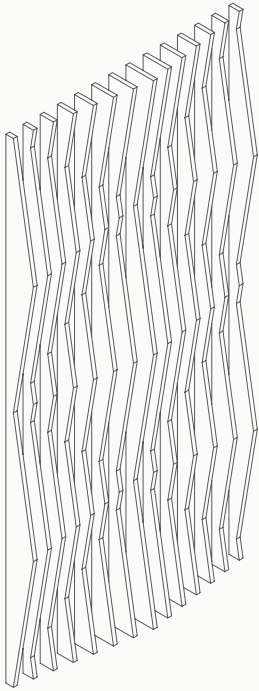

3D PANELS

SECTISDESIGN
where art & design meet™





WREN *SD_3D_008*



AVAILABLE COLORS



VERTICAL REPETITION

4' high

HORIZONTAL REPETITION

4' wide

STANDARD HEIGHT

8' high



IRIS

SD_3D_011

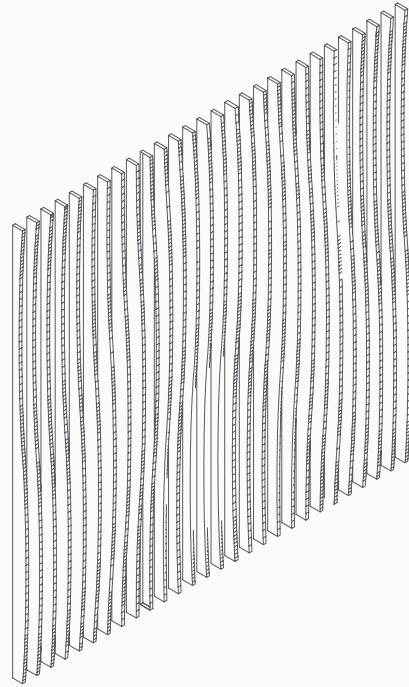

VERTICAL REPETITION

8' high

HORIZONTAL REPETITION

8' wide

STANDARD HEIGHT

8' high

AVAILABLE COLORS



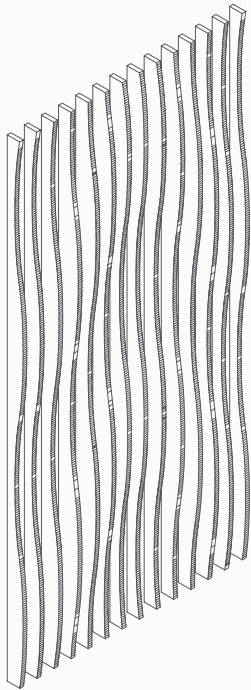

LUNA SD_3D_013



AVAILABLE COLORS



VERTICAL REPETITION

4' high

HORIZONTAL REPETITION

4' wide

STANDARD HEIGHT

8' high

LUNA - SD_3D_013

3D PANELS



RIVER SD_3D_014

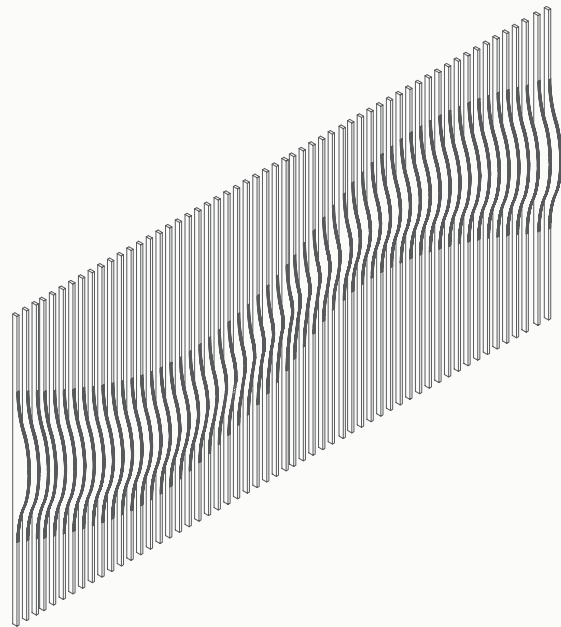

VERTICAL REPETITION

Does not repeat

HORIZONTAL REPETITION

20' wide

STANDARD HEIGHT

8' high

AVAILABLE COLORS



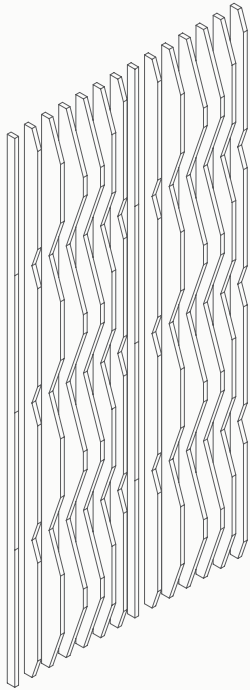

FLORA SD_3D_016



AVAILABLE COLORS



VERTICAL REPETITION

2' high

HORIZONTAL REPETITION

2' wide

STANDARD HEIGHT

8' high

FLORA - SD_3D_016

3D PANELS



NOVA

SD_3D_017

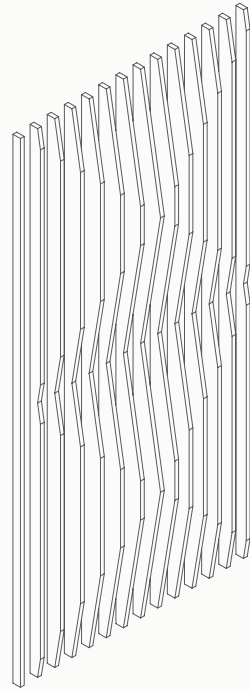

VERTICAL REPETITION

4' high

HORIZONTAL REPETITION

4' wide

STANDARD HEIGHT

8' high

AVAILABLE COLORS



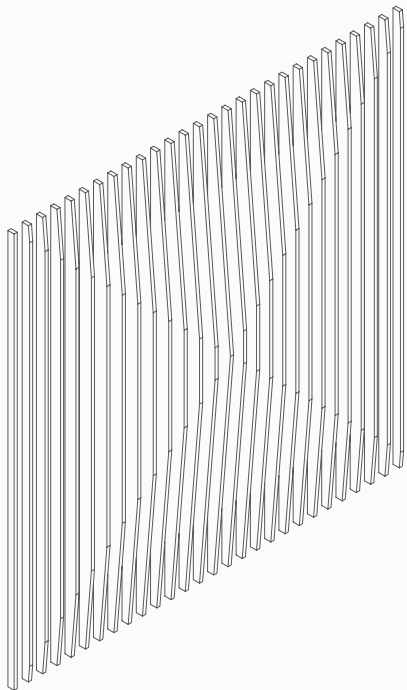

SAGE

SD_3D_018



AVAILABLE COLORS



VERTICAL REPETITION

8' high

HORIZONTAL REPETITION

8' wide

STANDARD HEIGHT

8' high

SECTIS DESIGN

where art & design meet™

Sectis caters the wow factor for all project sizes.

We adapt to your needs, you can choose from our catalogue of 3D panels design and colors. With that and your information of size & place we set the price and schedule your installation date.

If you have an idea in mind, reach out! A member of our design team would be happy to help you with any custom details you might be thinking of.

With SECTIS 3D panels you can give your space the touch of art and design it needs.

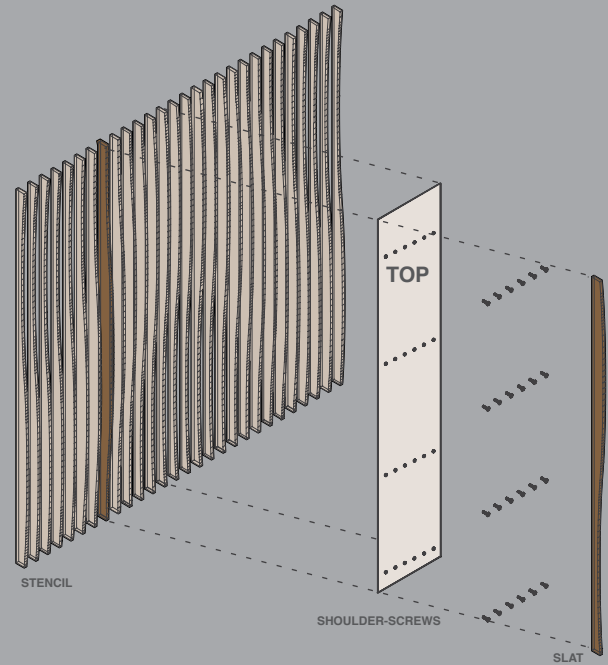

3D PANEL INSTALLATION GUIDE

IMPORTANT

Walls to be installed must have plywood backing.

Drywall (1/2" thick max.) must be installed directly over plywood.

Installation Instructions

- 1.- Place stencils provided, side to side, on the bottom left corner of desired wall.
- 2.- Using a marker, mark all of the hole openings.
- 3.- Remove stencils and place aside.
- 4.- Install "shoulder-screws" on the marks. Make sure the shoulder-screws are screwed into the plywood backer.

- 5.- Locate the slat to be installed (slats are numbered on its back).
- 6.- Slide the slat downwards inserting the head of the screws into the receiving hardware installed.
- 7.- Once all slats are installed, place the stencil directly onto the side of the last slat and continue with step 2.
- 8.- If wall has multiple sets vertically, each entire level must be installed at a time.

PRESERVED MOSS & ACOUSTIC FELT INSERTS

AVAILABLE

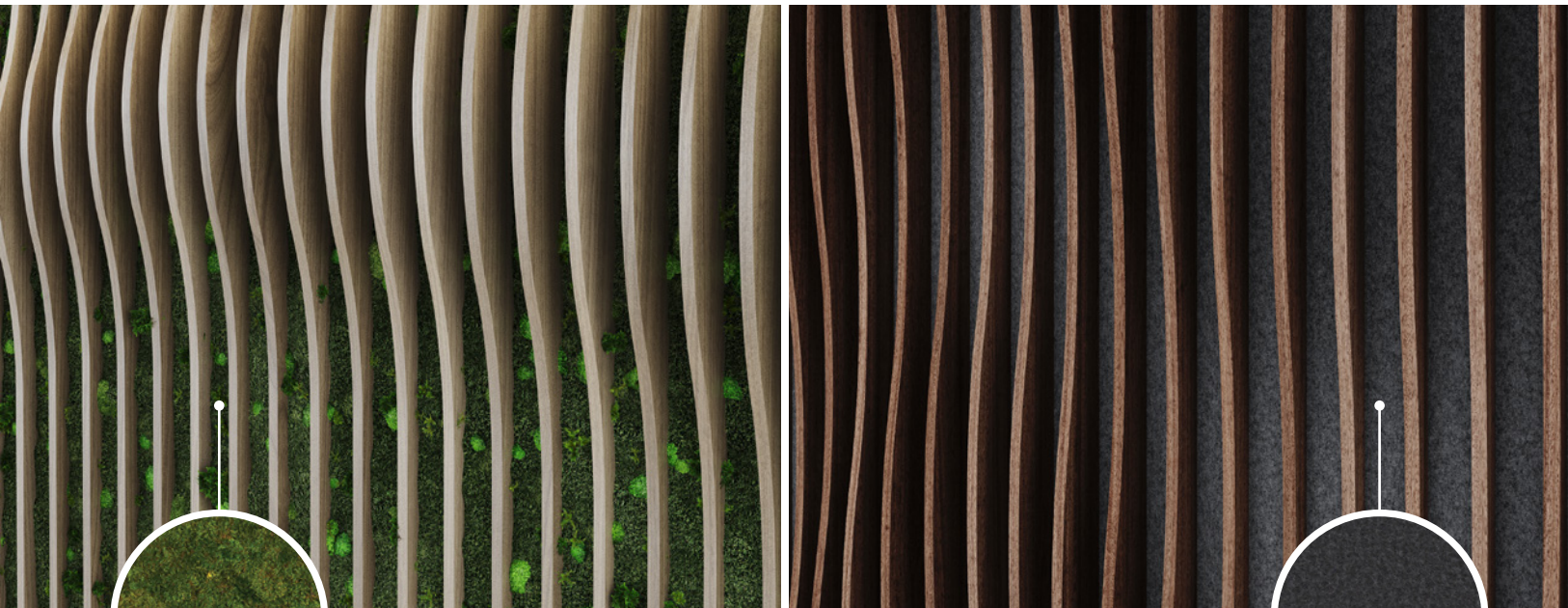

AVAILABLE COLORS



LB01



DS10



ES07



CG06



GA41



SD18



PB09



Many more



 @sectisdesign • info@sectisdesign.com • 2921 NW 6th Ave, Miami, FL 33127 USA

sectisdesign.com